

Installation Instructions



AM250 **Universal Swingout Arm**

NORTH AMERICA

3130 East Miraloma Avenue
Anaheim, CA 92806 USA
USA and Canada -
Phone: 800-368-9700
Fax: 800-832-4888

EUROPE

Swallow House,
Shilton Industrial Estate,
Shilton, Coventry, England CV79JY
Phone: +44 (0) 2476 614700
Fax: +44 (0) 2476 614710

ASIA

Nakaizumi 607-7,
Gunma-machi, Gunma-gun
Gunma-ken 370-3524, Japan
Phone: (81)-27-371-6998
Fax: (81)-27-371-6308

AUSTRALIA, NEW ZEALAND, OCEANIA (Distributor)

P.O. Box 295
Mordialloc Victoria 3195
Australia
Phone: 03 9586 6330
www.premiermounts.com.au



TABLE OF CONTENTS

Warranty	2
Contact Premier Mounts	2
Warning Statements	3
Parts List	4
Installation Tools.....	4
Thread Depth Indicator	7
Mount Installation	8
Universal Mounting Bracket Installation	9
Attaching the Display	10
Securing the Display	11
Tilt Positioning	11
Technical Specifications	12

Warranty

Limited Lifetime Warranty

All Premier Mounts products carry a limited lifetime warranty from ship date against defects in materials and workmanship. Premier Mounts is not liable for improper installation that results in damage to mounts, adapters, display equipment or personal injury.

DISCLAIMER OF WARRANTY

THE FOREGOING WARRANTY IS IN LIEU OF ALL OTHER WARRANTIES, EXPRESS OR IMPLIED, INCLUDING BUT NOT LIMITED TO THE IMPLIED WARRANTIES OF MERCHANTABILITY AND FITNESS FOR A PARTICULAR PURPOSE.

Contact Premier Mounts

In the event of missing and/or damage equipment, or technical questions, the following information can help in the completion of the installation.

Customer Service - (800) 368-9700
Technical Support - techsupport@mounts.com



Warning Statements

WARNING: PREMIER MOUNTS DOES NOT WARRANT AGAINST DAMAGE CAUSED BY THE USE OF ANY PREMIER MOUNTS PRODUCT FOR PURPOSES OTHER THAN THOSE FOR WHICH IT WAS DESIGNED OR DAMAGE CAUSED BY UNAUTHORIZED ATTACHMENTS OR MODIFICATIONS, AND IS NOT RESPONSIBLE FOR ANY DAMAGES, CLAIMS, DEMANDS, SUITS, ACTIONS OR CAUSES OF ACTION OF WHATEVER KIND RESULTING FROM, ARISING OUT OF OR IN ANY MANNER RELATING TO ANY SUCH USE, ATTACHMENTS OR MODIFICATIONS.

WARNING: THE WALL STRUCTURE MUST BE CAPABLE OF SUPPORTING AT LEAST A MAXIMUM WEIGHT OF 160 LBS. IF NOT, THE WALL MUST BE REINFORCED. PROPER INSTALLATION PROCEDURE BY A QUALIFIED SERVICE TECHNICIAN, AS OUTLINED IN THE INSTALLATION INSTRUCTIONS, MUST BE ADHERED TO. FAILURE TO DO SO COULD RESULT IN SERIOUS PERSONAL INJURY, OR EVEN DEATH. THE WEIGHT OF THE DISPLAY IS NOT TO EXCEED 125 LBS.

WARNING: SAFETY MEASURES MUST BE PRACTICED AT ALL TIMES DURING THE INSTALLATION OF THIS PRODUCT. USE PROPER SAFETY GEAR AND TOOLS FOR THE INSTALLATION PROCEDURE TO PREVENT PERSONAL INJURY.

WARNING: PRIOR TO THE INSTALLATION OF THIS PRODUCT, THE INSTALLATION INSTRUCTIONS SHOULD BE READ AND COMPLETELY UNDERSTOOD. THE INSTALLATION INSTRUCTIONS MUST BE READ TO PREVENT PERSONAL INJURY AND PROPERTY DAMAGE. KEEP THESE INSTALLATION INSTRUCTIONS IN AN EASILY ACCESSIBLE LOCATION FOR FUTURE REFERENCE.



Indicates that the power plug is to be disconnected from the power outlet.



Safety precautions must be taken at all times.



Warning and Caution statements.



A secure structure must support the weight, or load, of the display. When mounting to a wall that contains wooden studs, dead center of the wooden stud must be confirmed prior to installation.



Do not install on a structure that is prone to vibration, movement or chance of impact. Failure to do so could result in damage to the display and/or damage to the mounting surface.



Do not install near heater, fireplace, direct sunlight, air conditioning or any other source of direct heat energy. Failure to do so may result in damage to the display and could increase the risk of fire.



At least two qualified people should perform the installation procedure. Injury and/or damage can result from dropping or mishandling the display.



Recommended mounting surfaces: wooden studs and solid-flat concrete. If the mount is to be installed on any surface other than wooden studs, use suitable hardware (which is commercially available).



Contact Premier Mounts with any technical/ installation questions.



Parts List

NOTE: This mount is shipped with all installation hardware and components. Make sure that none of these parts are missing and/ or damaged before beginning installation. If there are parts missing and/or damaged, please stop and contact Premier Mounts (800) 368-9700.

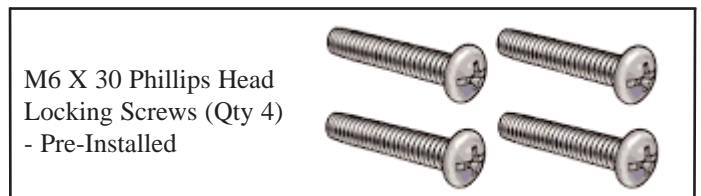
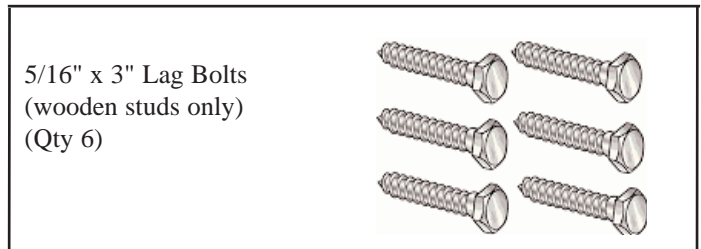
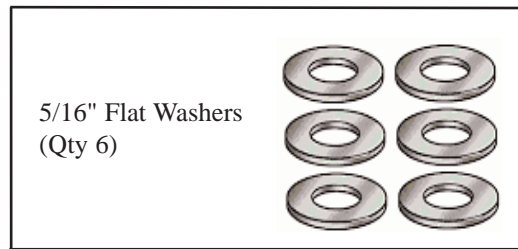
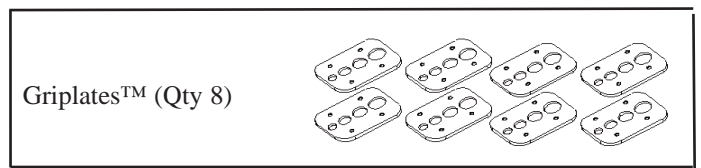

Installation Tools

Phillips Head Screw Driver
Pencil
Level (Supplied)
1/4" Drill Bit (Pilot Holes)

Soft Material/ Blanket
Tape Measure
Thread Depth Indicator (Supplied)

1/2" Socket and Wrench
Drill Gun





Parts List (Cont.)

M4 x 16  (Qty 8)

M6 x 20  (Qty 6)

M4 x 25  (Qty 4)

M6 x 30  (Qty 6)

M5 x 12  (Qty 8)

M8 x 20  (Qty 6)

M5 x 16  (Qty 6)

M5 x 20  (Qty 6)

M8 x 25  (Qty 6)

M5 x 25  (Qty 4)

M8 x 30  (Qty 6)

M5 x 50  (Qty 4)

M8 x 35  (Qty 4)

M6 x 12  (Qty 8)

M8 x 70  (Qty 4)



Parts List (Cont.)

Nylon spacers and flat washers' actual size

NOTE: The nylon spacers may be stacked to achieve proper spacing.

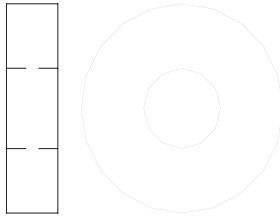

1/4" Nylon spacers
(large)
(Qty 6)

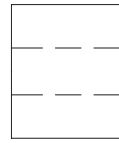

9/16" Nylon spacers
(Qty 6)

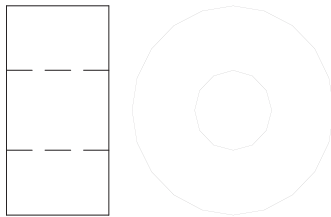

1/2" Nylon spacers
(large)
(Qty 12)

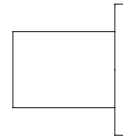

Nylon sleeves
(Qty 4)

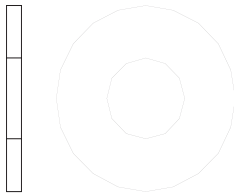

5/16" Flat washers
(metal)
(Qty 6)

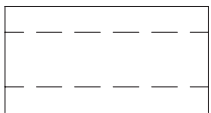

1" Nylon spacers
(Qty 6)

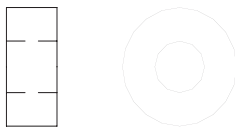

1/4" Nylon spacers
(Small)
(Qty 6)



Thread Depth Indicator

- Step 1. Insert the thread depth indicator (supplied) through the thread inserts found on the back of the flat panel to make sure the inserts measure the same full depth and mark it (Figure 1).
- Step 2. Locate the correct diameter screw for the thread insert. Compare your marking to the screws (supplied).
- Step 3. If your selected screw is longer than the marking on the thread depth indicator, DO NOT USE this screw.
- Step 4. The screw length must not bypass the marking. Select another screw size (Figure 2 and 3), until you find one that comes closest to your mark without going past.

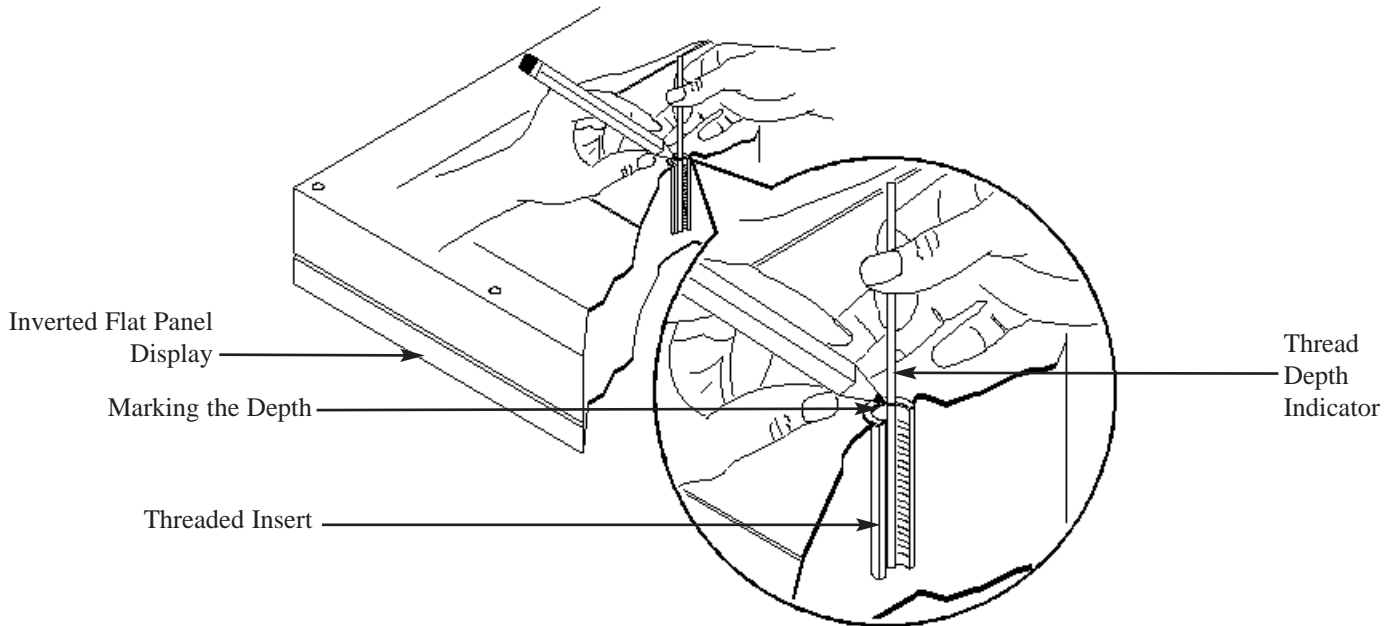

Figure 1

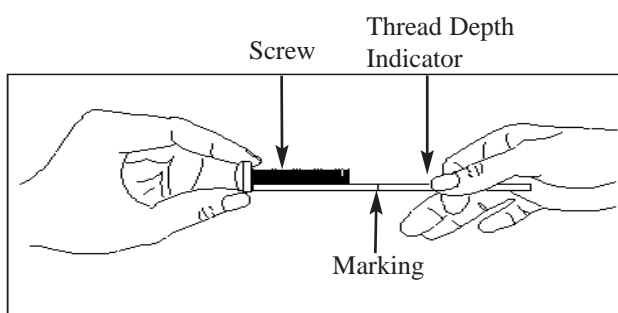

Figure 2

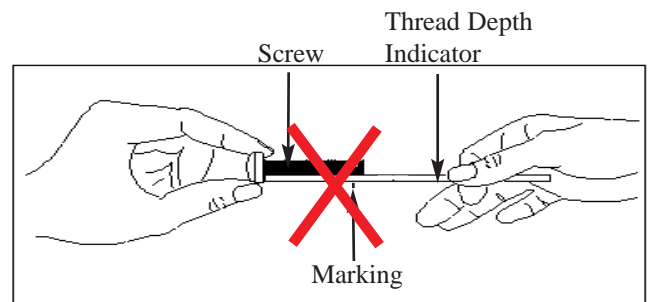

Figure 3



Mount Installation

WARNING: THE FOLLOWING STEPS SHOULD BE PERFORMED BY TWO PEOPLE.

NOTE: Before proceeding with the mount installation, you should already have the mounting holes pre-drilled. Please follow all instructions.

NOTE: After marking the wall and pre-drilling the upper mounting holes, please refer to Page 12, Technical Specifications, to correctly determine the distance between the upper and lower mounting point locations.



Step 1

Determine where the mount location will be. Use a stud finder to locate the nearest wall stud.



Step 2

Once the stud has been located, use a pencil to mark the spot.



Step 3

Using a 1/4" drill bit, drill the upper mounting hole where the mark was made.

NOTE: For ease of installation, it is recommended that two people perform the installation. One person should hold the mount while the other person installs the lag bolt and washer. Making sure that the mount is level, the person not holding the mount must mark and drill the second mounting hole and secure the second lag bolt and washer.



Step 4

After the holes have been pre-drilled, line up the mounting slot openings with the pre-drilled holes.



Step 5

Insert four (4) 5/16" x 3" lag bolts and washers into the mounting holes and tighten.



Step 6

Place a level (supplied) on the top rail and make sure that the mount is level. Once the mount is level, tighten down all lag bolts.

NOTE: If the studs are 12" apart, use three 3" lags bolts for the top rail and three 3" lag bolts for the lower rail. If the studs are 16", 18" or 24" apart, use two 3" lag bolts for the top rail and two 3" lag bolts for the lower rail.



Universal Mounting Bracket Assembly

- Step 1. Place the display on a soft, flat surface, face-down.
Step 2. Determine where the mounting points are located.
Step 3. Place the universal brackets over the mounting points.

NOTE: If the mounting surface is not completely level, use the spacers (see Page 6) to ensure that the universal brackets are level on the display.

- Step 4. Once the desired position has been determined, place the Griplates™ over each mounting point (dimples facing up) and secure them using the appropriate hardware (see Page 5).

NOTE: For the two upper mounting points, the dimples (Griplates™) must be facing up. For the two lower mounting points, the dimples (Griplates™) must be facing down.

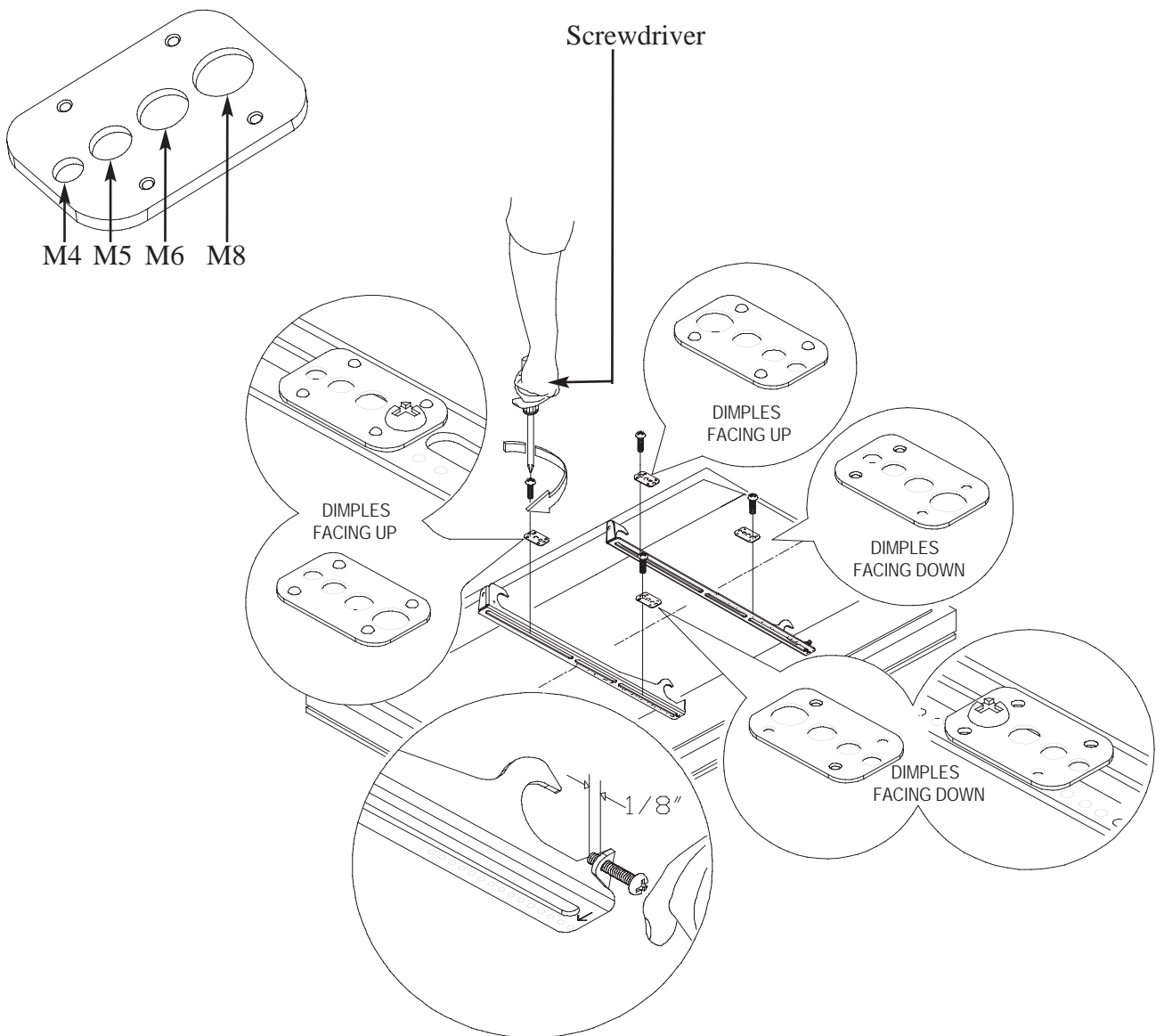



Attaching the Display

WARNING: IT IS RECOMMENDED THAT TWO PEOPLE MOUNT THE DISPLAY, AS THE UNIT IS HEAVY AND, IF DROPPED, WILL DAMAGE THE MOUNT, THE DISPLAY, AND/OR PERSONNEL.

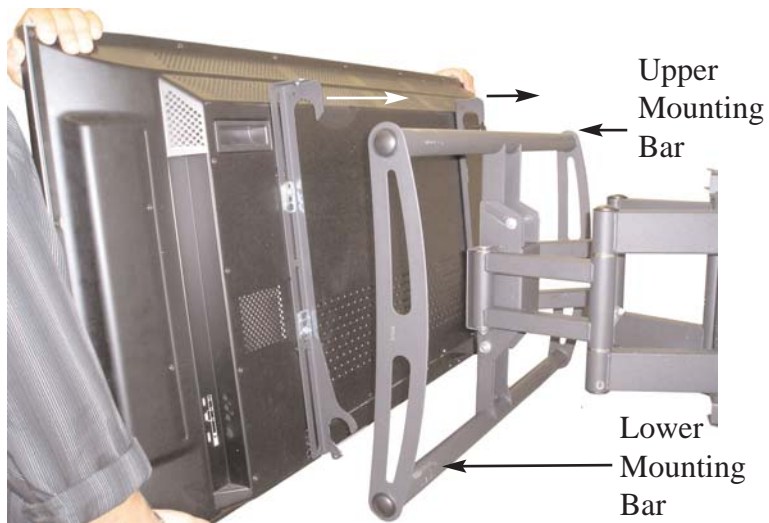

Step 1. Place the universal brackets and the display over the upper mounting bar of the AM250.

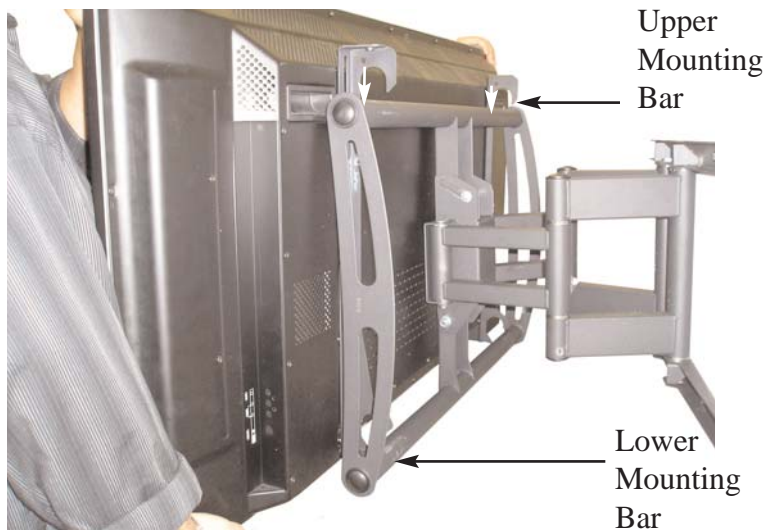

Step 2. Lower the universal mounting brackets and display onto the mounting bar of the AM250.



Step 3. This is what the two units will look like after the universal mounting brackets and display are mounted to the AM250.



Securing and Leveling the Display

Once the brackets have been placed over the upper mounting bars on the AM250, use two (2) M6 x 30mm Phillips Head locking screws to secure the brackets to the bottom of the mounting bars. This will prevent lateral shift movement. Level your flat panel by installing the two additional M6 x 30mm Phillips Head screws to the upper bracket assembly as shown below.



M6 x 30mm Phillips
Head Screw

Lower Locking Point



M6 x 30mm Phillips
Head Screw

Upper Bracket Leveling
Adjustment Screw

Tilt Positioning

NOTE: TO ADJUST THE TILT TENSION OF THE AM250, LOOSEN THE TENSION BOLTS LOCATED ON THE BOTTOM RIGHT AND LEFT SIDE OF THE MAIN ARM ASSEMBLY. RE-TIGHTEN THESE BOLTS TO ACHIEVE YOUR DESIRED TENSION.

To adjust the tilt of the display, place a hand in the top middle of the display and the other hand at the bottom middle of the display.

To Tilt the Display Forward

Gently pull on the upper portion of the display while pushing the lower end of the display away from you. This motion will cause the display to tilt forward.

To Tilt the Display Back

Gently push on the upper portion of the display and pull the lower end of the display towards you. This motion will cause the display to tilt back.

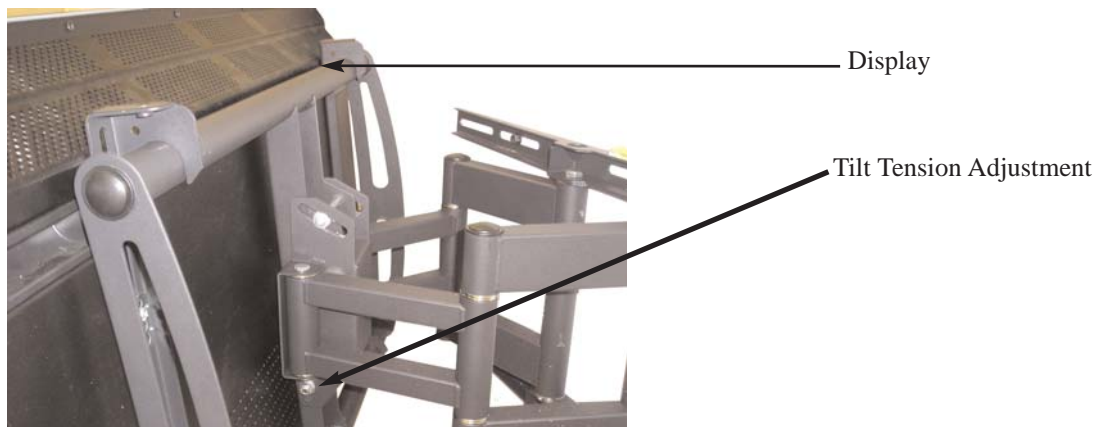



Technical Specifications

All measurements are in inches (mm).

